

Note!

Please note that there can be small differences between your product and the images in these instructions.

Note!

Please note that during storage and transport, especially at high ambient temperature, some of the oil and grease used for assembly may leak and stain the packaging. This will not cause damage to the product, wipe off the excessive oil or grease with a cloth.

Kit Contents

Description	Part No	Pcs
Shock absorber	YA 1893	1
Owner's manual	07253-03	1
Sticker Öhlins	10207-01	1
Spring clip	15087-02	1

Note!

No spring included in this kit. See the spring guide in this folder or contact an Öhlins dealer for advice.

Note!

Before you install this product, check the kit contents. If anything is missing, please contact an Öhlins dealer.

Warning!

Before you install this product, read the Öhlins Owner's manual. This product is an important part of the vehicle and the vehicle stability.

TTX Flow shock absorber for Yamaha YZ 250F

YA 1893

Mounting Instructions



MOUNTING INSTRUCTIONS

Install the spring

👁 **Note!**

Install the spring on the shock absorber before you install the shock absorber on the vehicle.

1

Measure the spring free length (A).

2

Loosen the lock nut so that you can move the spring platform as far up as needed to install the spring.

3

Put the shock absorber up-side-down in a vice. Install the spring.

👋 **Caution!**

Position the spring end between the two notches of the spring platform, see figure. If the spring end is positioned at one of the notches, the spring may be eccentrically positioned and may damage the reservoir.

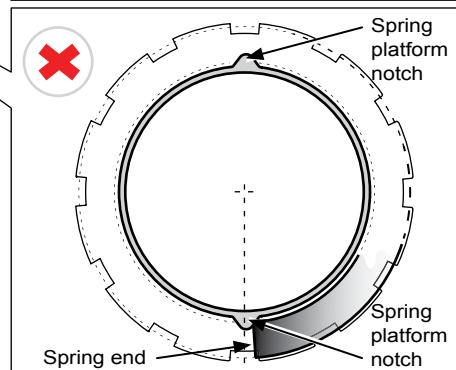
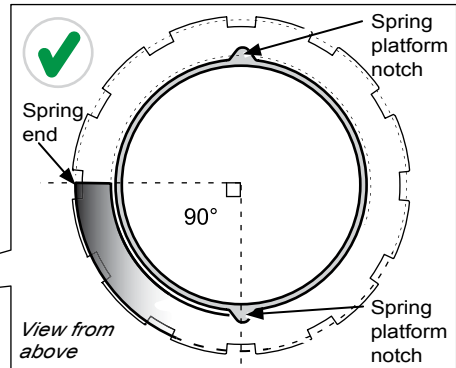
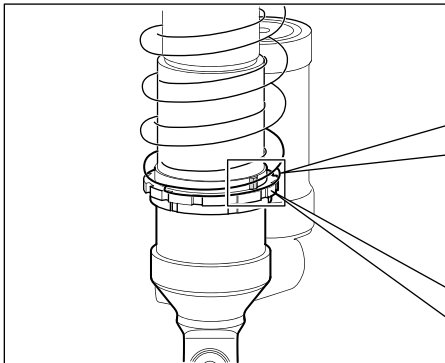
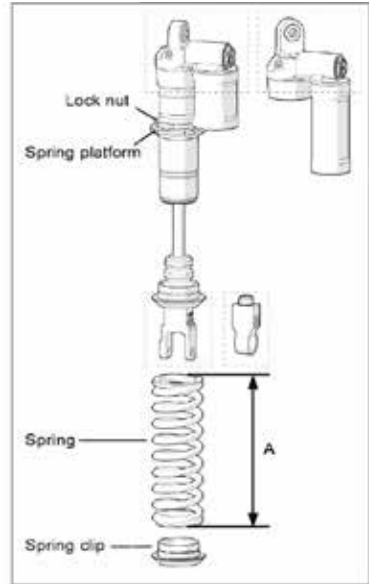

MOUNTING INSTRUCTIONS

4

Install the spring clip by sliding it over the end piece and the stop washer.

5

See the figure.

- The upper view shows the unlocked position.
- To lock: Turn the spring clip or the end piece 90° and pull it back towards the stop washer.

👁 **Note!**

If a spring assembly tool is used, the spring can be compressed by pushing on the spring clip and rotating the end piece to get the locked orientation.

6

Measure the spring length. Adjust the spring preload to the recommended setup data, found in these Mounting Instructions.

👉 **Caution!**

Tighten the preload lock nut before riding the vehicle.

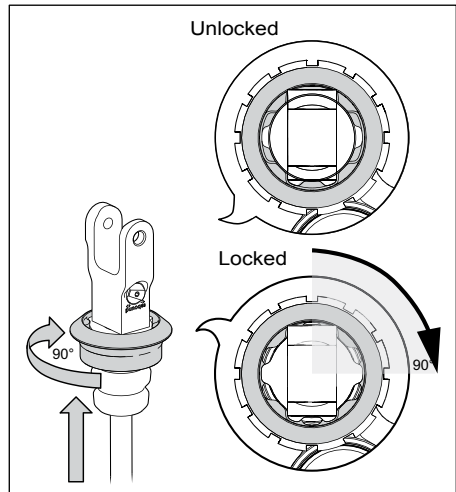
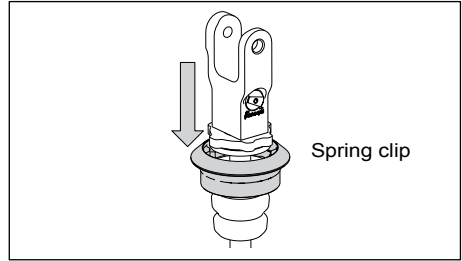

Install the Shock Absorber

⚠ **Warning!**

We strongly recommend to let an Öhlins dealer install this product.

⚠ **Warning!**

If you work with a lifted vehicle, make sure that it is safely supported to prevent it from tipping over.

👁 **Note!**

When you work with this product, see the vehicle service manual for vehicle specific procedures and important data.

👁 **Note!**

Before you install this product clean the vehicle.

1

Put the motorcycle on a work stand so that the rear wheel barely touches the ground.

2

Refer to the vehicle manual to install the Öhlins shock absorber.

👁 **Note!**

Lower the vehicle so that the suspension is slightly compressed before you tighten the screws.

👉 **Caution!**

Make sure that you tighten all screws to the correct torque and that nothing fouls or restricts movement of the shock absorber/front fork/steering damper when the suspension is fully compressed or extended.

SETUP DATA

Length	460	mm
Stroke	138	mm
Spring preload approx.	10 (5)	mm (turns)
Compr. low speed	6	clicks
Rebound	9	clicks

Free Sag and Ride Height		
R1-R2	38±5	mm
R1-R3	103±5	mm

SPRING GUIDE

YA 1893: Yamaha YZ 250F		
Rider's weight*	Spring	Spring rate
kg/pounds	part no	N/mm
60/132	06310-08	48
65/143	06310-09	50
70/154	06310-09	50
75/165	06310-10	52
80/176	06310-10	52
85/187	06310-11	54
90/198	06310-11	54
95/209	06310-12	56
100/220	06310-12	56
105/231	06451-13	58
110/242	06451-14	60
115/253	06451-15	62

**Rider's weight: Rider wearing proper riding gear. Make sure you know your total weight with riding gear. Riding gear weighs between 5 and 15 kg.*

Öhlins products are subject to continuous improvement and development, therefore, although these instructions include the most up-to-date information available at the time of printing, minor updates may occur.

To find the latest information contact an Öhlins distributor. Please contact Öhlins if you have any questions regarding the contents in this document.

Part no. MI_YA1893_0
Issued 2017-08-24

© Öhlins Racing AB. All rights reserved. Any reprinting or unauthorized use without the written permission of Öhlins Racing AB is prohibited.

Öhlins Racing AB
Box 722
S-194 27 Upplands Väsby, Sweden
Phone +46 8 590 025 00
fax +46 8 590 025 80



www.ohlins.com