

Kit Contents		
Description	Part No	Pcs
Sticker "ÖHLINS" Ye/bl	00192-01	2
Bracket assy 2205-11	02230-09	1
Steering damper str 140	02262-45	1
Owner's manual	07261-02	1

👁 Note!

Please note that there can be small differences between your product and the images in these instructions.

👁 Note!

Please note that during storage and transport, especially at high ambient temperature, some of the oil and grease used for assembly may leak and stain the packaging. This will not cause damage to the product, wipe off the excessive oil or grease with a cloth.

👁 Note!

Before you install this product, check the kit contents. If anything is missing, please contact an Öhlins dealer.

⚠ Warning!

Before you install this product, read the Öhlins Owner's manual. This product is an important part of the vehicle and the vehicle stability.

Steering damper universal 140 mm stroke

SD 004

Mounting Instructions



MOUNTING INSTRUCTIONS

Warning!

We strongly recommend to let an Öhlins dealer install this product.

Warning!

If you work with a lifted vehicle, make sure that it is safely supported to prevent it from tipping over.

Note!

When you work with this product, see the vehicle service manual for vehicle specific procedures and important data.

Note!

Before you install this product clean the vehicle.

1

Install the bracket assembly (02230-09) on the Öhlins steering damper. See the figure.

Adjust the steering damper by letting it slide in its bracket assembly so that the steering damper uses the same stroke both ways.

Note!

Make sure that the steering has clearance for turning both to the left and to the right end positions, and that the damper is not used as a stop.

2

Read more about the steering damper and its different settings in your Öhlins Owners Manual.

Caution!

Make sure that all screws are tightened to the correct torque and that nothing fouls or restricts movement of the steering damper.

MOUNTING INSTRUCTIONS

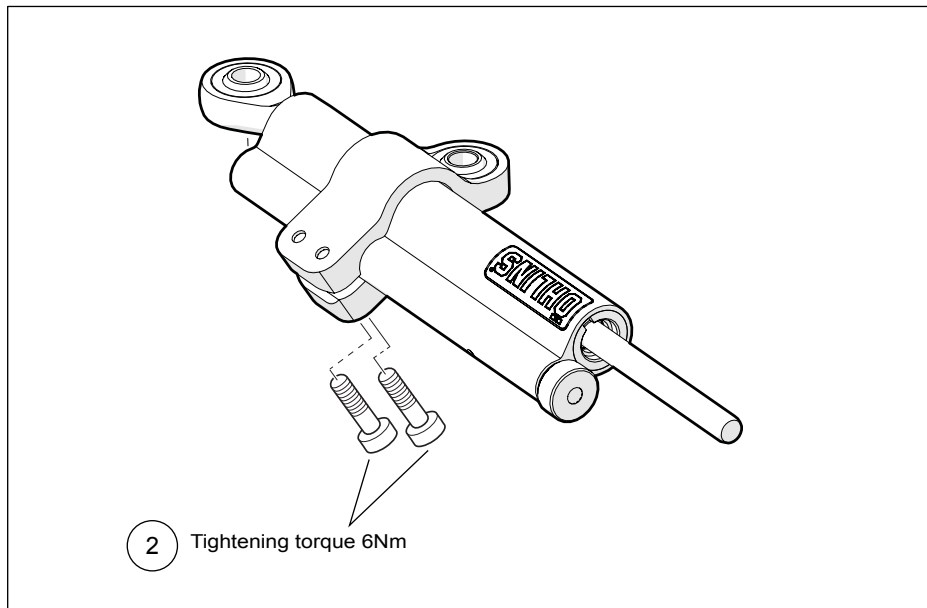

ADJUSTMENTS

⚠ Warning!

Before you ride/drive, always make sure that the setup is according to the recommended setup data. Read about adjustments and setting up in the Öhlins Owner's Manual before you make any adjustments. Contact an Öhlins dealer if you have any questions about setting up.

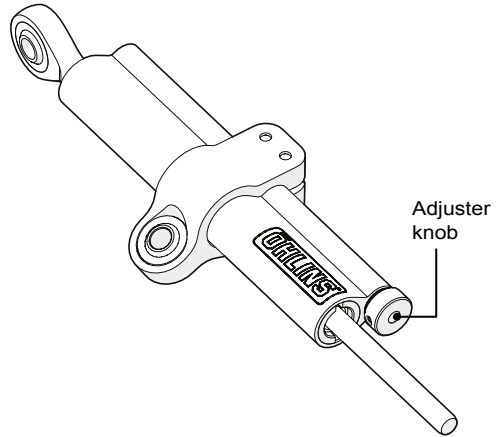

SETUP DATA

Recommended setup	10	clicks
-------------------	----	--------

Öhlins products are subject to continuous improvement and development, therefore, although these instructions include the most up-to-date information available at the time of printing, minor updates may occur.

To find the latest information contact an Öhlins distributor. Please contact Öhlins if you have any questions regarding the contents in this document.

Part no. MI_SD004_0
Issued 2019-03-19

© Öhlins Racing AB. All rights reserved. Any reprinting or unauthorized use without the written permission of Öhlins Racing AB is prohibited.

Öhlins Racing AB
Box 722
S-194 27 Upplands Väsby, Sweden
Phone +46 8 590 025 00
fax +46 8 590 025 80



www.ohlins.com