

Note!

Please note that there can be small differences between your product and the images in these instructions.

Note!

Please note that during storage and transport, especially at high ambient temperature, some of the oil and grease used for assembly may leak and stain the packaging. This will not cause damage to the product, wipe off the excessive oil or grease with a cloth.

Kit Contents		
Description	Part No	Pcs
Shock absorber	HD 757	1
Tool	03199-01	1
Sleeve	00123-17	4
Washer	03118-22	4
Washer	03118-23	4
Sticker	01185-01	2
Sticker	00185-04	2
Owner's manual	07241-02	1

Note!

Before you install this product, check the kit contents. If anything is missing, please contact an Öhlins dealer.

Warning!

Before you install this product, read the Öhlins Owner's manual. This product is an important part of the vehicle and the vehicle stability.

Shock absorber for Harley Davidson Sportster

HD 757

Mounting Instructions



MOUNTING INSTRUCTIONS

Warning!

We strongly recommend to let an Öhlins dealer install this product.

Warning!

If you work with a lifted vehicle, make sure that it is safely supported to prevent it from tipping over.

Note!

When you work with this product, see the vehicle service manual for vehicle specific procedures and important data.

Note!

Before you install this product clean the vehicle.

1

Put the motorcycle on a work stand so that the rear wheel barely touches the ground.

2

Loosen and remove the original shock absorber.

3

Install the Öhlins shock absorber in the same position as the original shock absorbers. The fill screw pointing towards the rear.

Note!

Lower the vehicle so that the suspension is slightly compressed before you tighten the screws.

Caution!

Make sure that you tighten all screws to the correct torque and that nothing fouls or restricts movement of the shock absorber/front fork/steering damper when the suspension is fully compressed or extended.

MOUNTING INSTRUCTIONS

1

wheel side

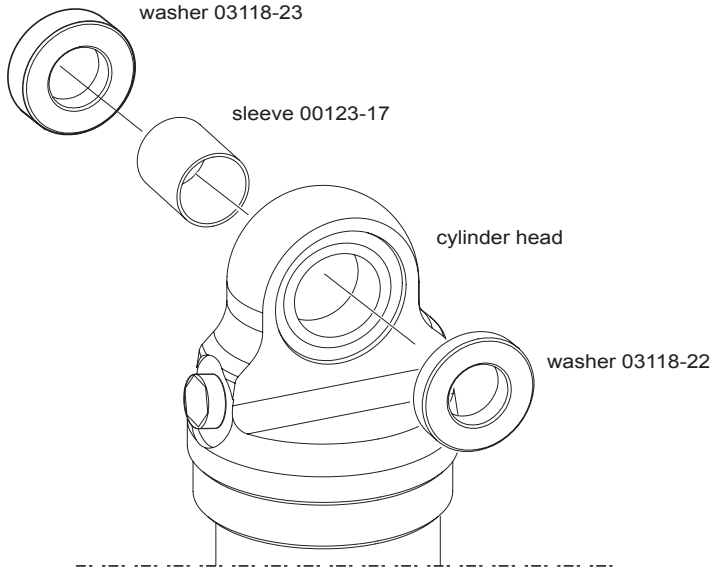

wheel side

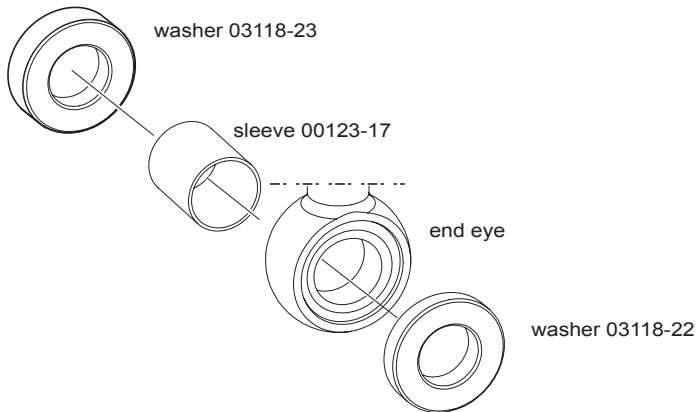

ADJUSTMENTS

⚠ Warning!

Before you ride/drive, always make sure that the setup is according to the recommended setup data. Read about adjustments and setting up in the Öhlins Owner's Manual before you make any adjustments. Contact an Öhlins dealer if you have any questions about setting up.

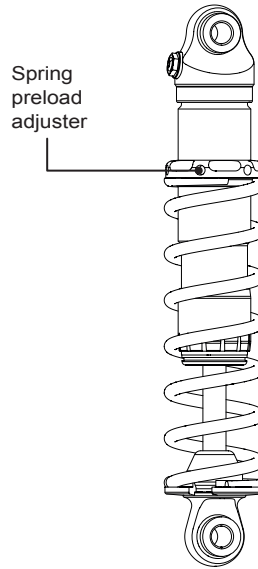

SETUP DATA

Length	279	mm
Stroke	42	mm
Spring preload	21	mm
Spring	00280-21	
Spring length	200	mm
Spring rate	25	N/mm

Öhlins products are subject to continuous improvement and development, therefore, although these instructions include the most up-to-date information available at the time of printing, minor updates may occur.

To find the latest information contact an Öhlins distributor. Please contact Öhlins if you have any questions regarding the contents in this document.

Part no. MI_HD757_0
Issued 2015-10-29

© Öhlins Racing AB. All rights reserved. Any reprinting or unauthorized use without the written permission of Öhlins Racing AB is prohibited.

Öhlins Racing AB
Box 722
S-194 27 Upplands Väsby, Sweden
Phone +46 8 590 025 00
fax +46 8 590 025 80



www.ohlins.com