

Note!

No springs included in this kit. Use appropriate Öhlins Front Fork springs, part no. 08765-XX. See the Spring guide in this folder or contact Öhlins for advice.

Note!

Please note that this image is a general representation of the product and may differ slightly from your product.

Note!

Please note that during storage and transportation, especially at high ambient temperature, some of the oil and grease used for assembling may leak and stain the packaging. This is in no way detrimental to the product, wipe off the excessive oil/grease with a cloth.

Kit Contents		
Description	Part No	Pcs
TTX Cartridge Kit	FCX 203-21	1
TTX Cartridge sticker	00191-63	2
Sticker set Öhlins		1
Owner's manual	07296-91	1
Base plug (with o-rings)	15430-03	2
Circlip	15440-01	2
Spacer 2 mm	15443-02	10
Spacer 10 mm	15443-10	2
Sticker service schedule MX fork & shock	15211-01	1

Note!

Before installing this product, check the contents of the kit. If anything is missing, please contact an Öhlins dealer.

Warning!

Before installing this product, read the Öhlins Owner's Manual. The shock absorber/front fork/steering damper is an important part of your vehicle and will affect the stability.

TTX Cartridge Kit for Kawasaki KX 250F, Suzuki RM-Z 250 & Yamaha YZ 250F/450F

FCX 203-21

Mounting Instructions



MOUNTING INSTRUCTIONS

SPECIAL TOOLS

Tool	Part no	Size
OEM Fork cap tool, octagon		49 mm
Öhlins Fork cap tool, octagon	01892-03	50 mm

MOUNTING INSTRUCTIONS

Remove the original fork legs

⚠ Warning!

We strongly recommend to let an Öhlns dealer install this product.

⚠ Warning!

If you work with a lifted vehicle, make sure that it is safely supported to prevent it from tipping over.

👁 Note!

When you work with this product, see the vehicle service manual for vehicle specific procedures and important data.

👁 Note!

Before you install this product clean the vehicle.

1
Place the motorcycle on a work stand so that the front wheel barely touches the ground.

2
Remove the front wheel, plastic fork leg protectors and the brake caliper.

3
Measure the distance from the top of the upper triple clamp to the center of the front wheel axle, see figure.

Note measure	
Fork height position	

4
Loosen the upper triple clamp screws.

5
Loosen the top cap ½ turn. Use an OEM Fork cap tool.

6
Loosen the lower triple clamp screws.

7
Remove the fork legs from the vehicle.

8
Clean the fork legs, make sure to clean underneath the fork bottom.

9
Refer to the vehicle service manual to remove the original front fork and spring from the fork leg. Turn the fork legs upside down and pour out all oil.

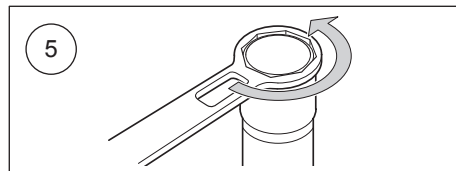
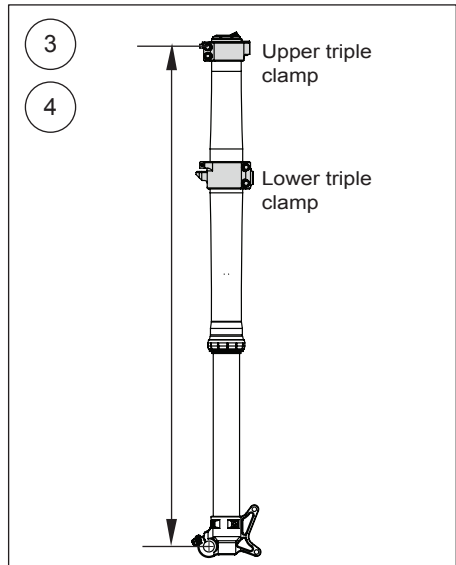
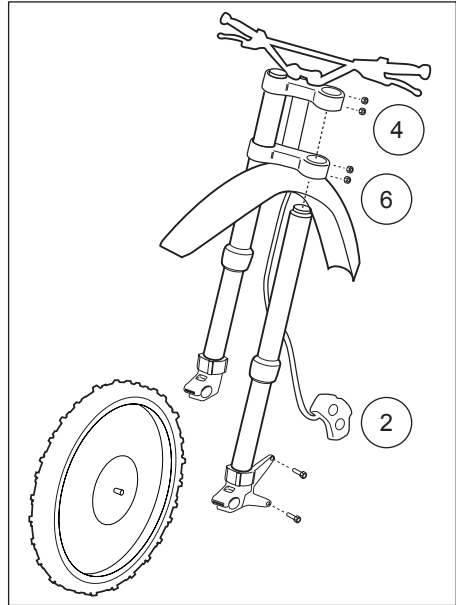

MOUNTING INSTRUCTIONS

Install the Öhlins cartridge kit

👁 **Note!**

Standard OEM hydraulic stop cup is used together with the Öhlins cartridge kit.

10

Install and tighten the base plug into the fork bottom, tighten to 45 Nm.

11

Apply grease on the thread of the piston rod end.

12

Insert, if any, the preload washer/s, recommended spring and the cartridge kit into the original fork leg.

👁 **Note!**

Place the preload washer/s below the spring, at the bottom end of the fork leg.

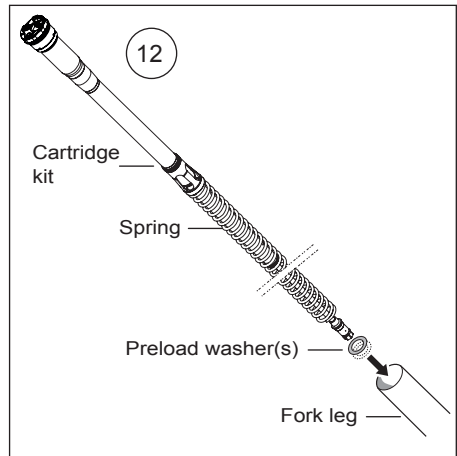
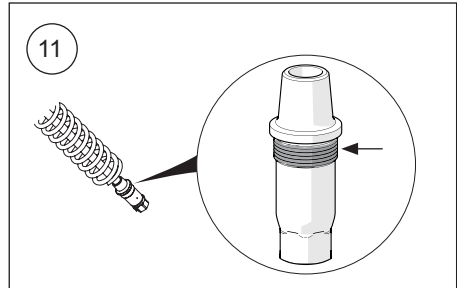

MOUNTING INSTRUCTIONS

13

Use a 12 mm socket to tighten the cartridge shaft end into the base plug, turn counter clockwise and tighten to maximum 18 Nm. *Do not over tighten.*

14

Install the security snap-ring at the shaft end groove.

15

Pour Öhlins Front fork fluid in the fork leg, refer to the recommended setup in Setup data.

16

Make sure that the front fork is fully extended. Use to tighten the Öhlins fork top cap to maximum 10 Nm.

17

Check and set the rebound and compression valves click positions, refer to the recommended setup in Setup data.

18

Install the front fork legs into the triple clamps. Set the fork legs at the same height position as before. Refer to the vehicle service manual for correct tightening torque.

👁 **Note!**

The front fork length might change when installing the Öhlins cartridge kit. See setup data for front fork length before and after installation of Öhlins cartridge kit.

19

Install the brake caliper and the front wheel. Make sure that all removed parts are installed in the same positions that they were before.

👁 **Note!**

It is very important to tighten the triple clamps to the correct torque, refer to the vehicle service manual.

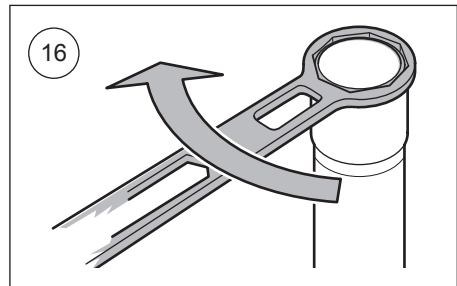
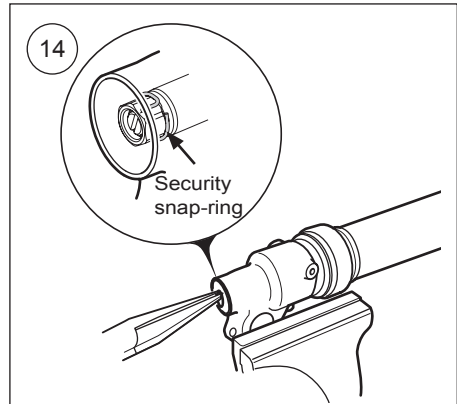
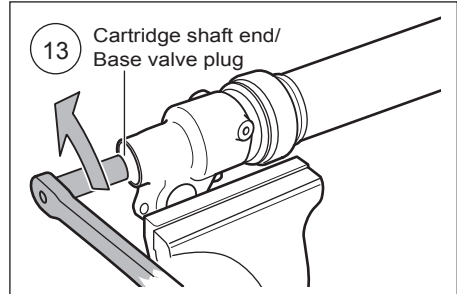

MOUNTING INSTRUCTIONS

SETUP DATA

Front fork length Suzuki RM-Z 250 & Yamaha YZ 250F/450F (OEM)	942	mm
Front fork length Kawasaki KX 250F (OEM)	948	mm
Front fork length Kawasaki KX 250F, Suzuki RM-Z 250 & Yamaha YZ 250F/450F (Öhlins cartridge kit)	947	mm
Front fork stroke Suzuki RM-Z 250 & Yamaha YZ 250F/450F (Öhlins cartridge kit)	302	mm
Front fork stroke Kawasaki KX 250F (Öhlins cartridge kit)	300	mm

Öhlins cartridge kit length	953	mm
Rebound damping	14	clicks
Compression damping	14	clicks
Spring preload*	10	mm
Total spring installation length Suzuki RM-Z 250 & Yamaha YZ 250F/450F	487	mm
Total spring installation length Kawasaki KX 250F	474	mm

Fluid volume 450 (each leg)	0,380	litre
Fluid volume 250 (each leg)	0,360	litre
Fluid volume range	0,300-0,400 litre	
Öhlins front fork fluid	01330-XX	

Recommended preload range:

Over all spring rate [N/mm]	4,1	4,2	4,3	4,4	4,5	4,6	4,7	4,8	4,9	5,0	5,1	5,2
Rec. preload range [mm]	8-13	8-13	8-12	8-12	8-12	8-12	8-11	8-11	7-11	7-11	7-11	7-11

Adjust by adding/removing preload washer(s) 15443-XX.

*To achieve specified spring preload the total spring installation length can be controlled prior installation into fork leg. See model specific length in setup data.

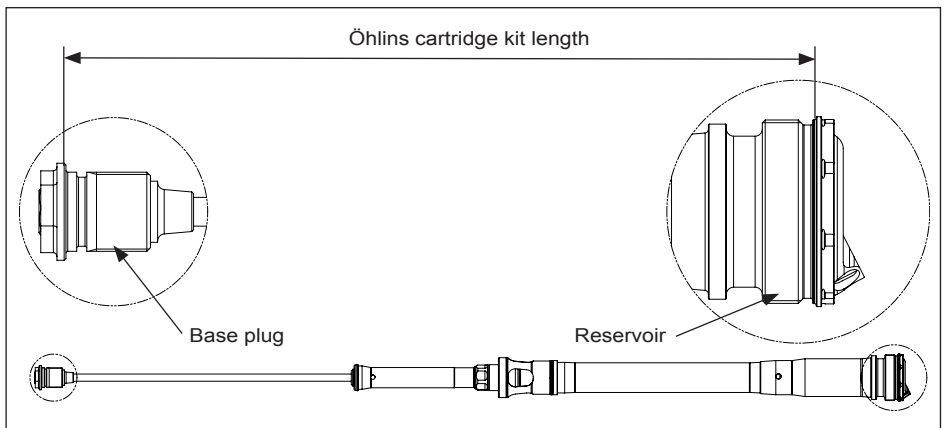
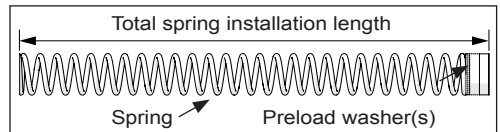

MOUNTING INSTRUCTIONS

SPRING GUIDE

Kawasaki KX, Suzuki RM-Z & Yamaha YZ						
	250F, 250 & 250F			450F		
kg/pound *	Low	Mid	High	Low	Mid	High
60/132	4,3	4,4	4,5	4,5	4,6	4,7
65/143	4,4	4,5	4,6	4,6	4,7	4,8
70/154	4,4	4,5	4,6	4,6	4,7	4,8
75/165	4,5	4,6	4,7	4,7	4,8	4,9
80/176	4,5	4,6	4,7	4,7	4,8	4,9
85/187	4,6	4,7	4,8	4,8	4,9	5,0
90/198	4,6	4,7	4,8	4,8	4,9	5,0
95/209	4,6	4,7	4,8	4,8	4,9	5,0
100/220	4,7	4,8	4,9	4,9	5,0	5,1
105/231	4,7	4,8	4,9	4,9	5,0	5,1
110/242	4,8	4,9	5,0	5,0	5,1	5,2
115/253	4,8	4,9	5,0	5,0	5,1	5,2
120/264	4,9	5,0	5,1	5,1	5,2	5,3
125/275	5,1	5,2	5,3	5,3	5,4	5,5

Available spring rates 08765-series:

-39, -41, -43, -45, -47, -49, -51, -53

To get spring rates between the available rates, combine two springs with different rates. One with a lower and one with a higher spring rate. Example: To get spring rate 4,6: Use spring with 4,5 in one fork leg and 4,7 in the other fork leg.

**Rider's weight: Rider wearing proper riding gear. Make sure you know your total weight with riding gear. Riding gear weighs between 5 and 15 kg.*

Öhlins products are subject to continuous improvement and development, therefore, although these instructions include the most up-to-date information available at the time of printing, minor updates may occur.

To find the latest information contact an Öhlins distributor. Please contact Öhlins if you have any questions regarding the contents in this document.

Part no. MI_FCX 203-21_0
Issued 2020-10-02

© Öhlins Racing AB. All rights reserved. Any reprinting or unauthorized use without the written permission of Öhlins Racing AB is prohibited.

Öhlins Racing AB
Box 722
S-194 27 Upplands Väsby, Sweden
Phone +46 8 590 025 00
fax +46 8 590 025 80



www.ohlins.com