

**Note!**

Please note that the images in this folder are a general representation of the product and may differ slightly from your product.

**Note!**

Please note that during storage and transportation, especially at high ambient temperature, some of the oil and grease used for assembling may leak and stain the packaging. This is in no way detrimental to the product, wipe off the excessive oil/grease with a cloth.

**Kit Contents**

Description	Part No	Pcs
Front Fork RXF 48 kit	FGKA1997	1
TTX Cartridge sticker	00191-63	2
Sticker set Öhlins		1
Owner's manual	07295-32	1
Sticker service schedule MX fork & shock	15211-01	1

**Note!**

Before installing this product, check the contents of the kit. If anything is missing, please contact an Öhlins dealer.

**Warning!**

Before installing this product, read the Öhlins Owner's Manual. The shock absorber/front fork/steering damper is an important part of your vehicle and will affect the stability.

**RXF Front Fork kit for Kawasaki KX 250 F**

***FGKA 1997***

**Mounting Instructions**



# MOUNTING INSTRUCTIONS

## **⚠ Warning!**

*We strongly recommend to let an Öhlins dealer install this product.*

## **⚠ Warning!**

*If you work with a lifted vehicle, make sure that it is safely supported to prevent it from tipping over.*

## **👁 Note!**

*When you work with this product, see the vehicle service manual for vehicle specific procedures and important data.*

## **👁 Note!**

*Before you install this product clean the vehicle.*

**1**

Place the motorcycle on a work stand so that the rear wheel barely touches the ground.

**2**

Remove the front wheel, plastic fork leg protectors and the brake caliper.

**3**

Measure the distance from the top of the upper triple clamp to the center of the front wheel axel, see figure.

Note measure	
Fork height position	

**4**

Loosen the upper triple clamp screws.

**5**

Loosen the lower triple clamp screws.

**6**

Remove the fork legs from the vehicle.

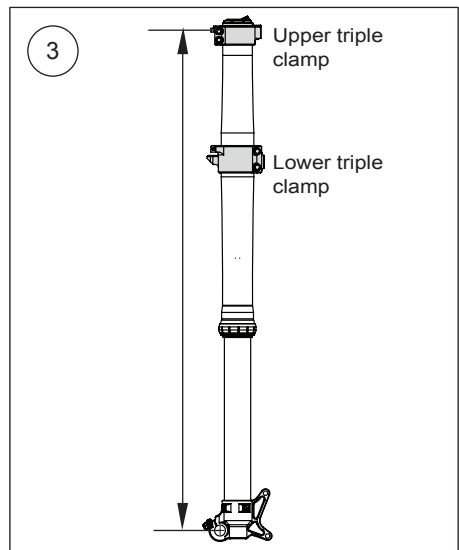
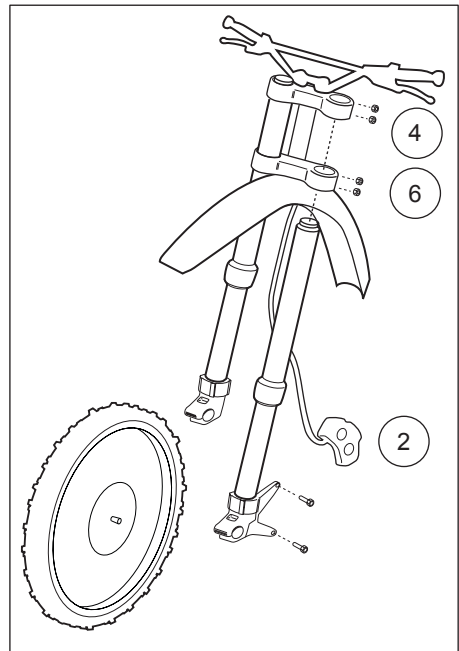

# MOUNTING INSTRUCTIONS

7

Install the fork legs into the triple clamps. Use, to start with, the same height position as measured in step 3. Rotate the fork legs in the triple clamps to get access to the adjusters in the fork leg top cap. We recommend to rotate the adjuster access point towards the rear of the motorcycle, the "Ö"-logo readable from riding position.

8

Place the upper fork leg sticker and insert the lower plastic fork leg protectors, tighten the plastic fork leg protectors M6 to 7 Nm. Refer to the vehicle service manual to tighten the top and bottom triple clamp bolts to correct torque.

## **Caution!**

---

*It is very important to tighten the triple clamps to the correct torque, refer to the vehicle service manual.*

---

9

Install the brake caliper and the front wheel. Tighten the brake caliper bolts. Tighten the front wheel nut and the left side fork bottom screws. Make sure front fork legs are parallel before you tighten the right side fork bottom screws. Refer to the vehicle service manual to tighten the brake caliper and the front wheel axle to correct torque.

Tighten the fork bottom M8 to maximum 15 Nm.

## **Warning!**

---

*Do not over tighten the fork bottom M8 screws.*

---

10

Make sure that all removed parts are installed correctly, refer to the instructions in the vehicle service manual.

# SETUP DATA

Front fork length	946	mm
Front fork stroke	304	mm
Rebound damping	14	clicks
Compression damping	14	clicks
Fluid volume (each leg)	0,360	litre
Volume range (each leg)	0,300-0,400	litre
Öhlins Front Fork fluid	01330-xx	

Spring		
Installed spring	08765-47	
Spring rate	4,7	N/mm
Spring free length	467±3	mm
Spring preload**	10	mm
Total spring installation length	489	mm

Recommended preload range:												
Over all spring rate [N/mm]	4,1	4,2	4,3	4,4	4,5	4,6	4,7	4,8	4,9	5,0	5,1	5,2
Rec. preload range [mm]	8-13	8-13	8-12	8-12	8-12	8-12	8-11	8-11	7-11	7-11	7-11	7-11

Adjust by adding/removing preload washer(s) 15443-XX.

\*\*To achieve specified spring preload the total spring installation length can be controlled prior installation into fork leg. See model specific length in setup data.

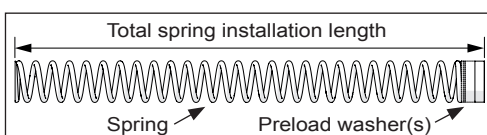

# SPRING GUIDE

Kawasaki KX 250 F			
kg/pound*	Low	Mid	High
60/132	4,3	4,4	4,5
65/143	4,4	4,5	4,6
70/154	4,4	4,5	4,6
75/165	4,5	4,6	4,7
80/176	4,5	4,6	4,7
85/187	4,6	4,7	4,8
90/198	4,6	4,7	4,8
95/209	4,6	4,7	4,8
100/220	4,7	4,8	4,9
105/231	4,7	4,8	4,9
110/242	4,8	4,9	5,0
115/253	4,8	4,9	5,0
120/264	4,9	5,0	5,1
125/275	5,1	5,2	5,3

Available spring rates 08765-series:  
-39, -41, -43, -45, -47, -49, -51, -53

To get spring rates between the available rates, combine two springs with different rates. One with a lower and one with a higher spring rate. Example: To get spring rate 4,6: Use spring with 4,5 in one fork leg and 4,7 in the other fork leg.

*\*Rider's weight: Rider wearing proper riding gear.*

*Make sure you know your total weight with riding gear. Riding gear weighs between 5 and 15 kg.*

Öhlins products are subject to continuous improvement and development, therefore, although these instructions include the most up-to-date information available at the time of printing, minor updates may occur.

To find the latest information contact an Öhlins distributor. Please contact Öhlins if you have any questions regarding the contents in this document.

Part no. MI\_FGKA1997\_0  
Issued 2018-09-18

© Öhlins Racing AB. All rights reserved. Any reprinting or unauthorized use without the written permission of Öhlins Racing AB is prohibited.

Öhlins Racing AB  
Box 722  
S-194 27 Upplands Väsby, Sweden  
Phone +46 8 590 025 00  
fax +46 8 590 025 80



[www.ohlins.com](http://www.ohlins.com)