

Owners Manual

Öhlins shock absorbers, Motorcycle Road & Track



Including:

Safety

Tuning the
suspension

Design
features

Function

Basic
adjustments

Fine tuning

Inspection,
maintenance



Safety signals

Important information concerning safety is distinguished in this manual by the following notations:



*The Safety alert symbol means:
Caution! Your safety is involved.*

WARNING!

*Failure to follow warning instructions could result in **severe or fatal injury** to anyone working with, inspecting or using the suspension, or to bystanders.*

CAUTION!

Caution indicates that special precautions must be taken to avoid damage to the suspension.

NOTE!

This indicates information that is of importance with regard to procedures.

Introduction

All of Öhlins advanced suspension products are adapted to the brand and model. This means that length, travel spring action and damping characteristics, are tested individually just for the motorcycle that you have decided to fit with Öhlins suspension.

Before installation

Öhlins Racing AB can not be held responsible for any damage whatsoever to shock absorber or vehicle, or injury to persons, if the instructions for fitting and maintenance are not followed exactly.

Similarly, the warranty will become null and void if the instructions are not adhered to.

Contents

Safety signals	2
Introduction	2
Before installation	2
Tuning the suspension	3
Design	3
Function	4
Settings	5
Setting the spring pre-load	5
Setting the damping	7
EC – Electronic Control settings	8
Setting your motorcycle	9
Inspection and maintenance	11

WARNING!

1. Installing a shock absorber, that is not approved by the vehicle manufacturer, may affect the stability of your vehicle. Öhlins Racing AB cannot be held responsible for any personal injury or damage whatsoever that may occur after fitting the shock absorber. Contact an Öhlins dealer or other qualified person for advice.

2. Please study and make certain that you fully understand all the mounting instructions and the owners manuals before handling this shock absorber kit. If you have any questions regarding proper installation procedures, contact an Öhlins dealer or other qualified person.

3. The vehicle service manual must be referred to when installing the Öhlins shock absorber

NOTE

Öhlins products are subject to continual improvement and development. Consequently, although these instructions include the most up-to-date information available at the time of printing, there may be minor differences between your suspension and this manual. Please consult your Öhlins dealer if you have any questions with regard to the contents of the manual.

© Öhlins Racing AB.

All rights reserved.

Any reprinting or unauthorized use without the written permission of Öhlins Racing AB is prohibited.

Printed in Sweden.

1. Design principles

1. Emulsion shock absorber
2. Internal gas reservoir
3. External piggyback reservoir
4. External reservoir with hose connection

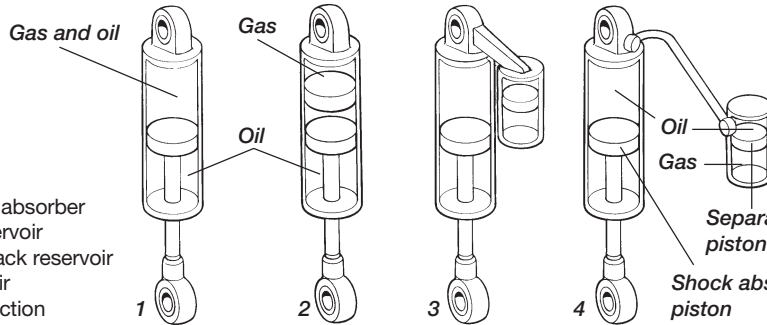

2. Spring pre-loading

Mechanical adjustment Hydraulic pre-loader

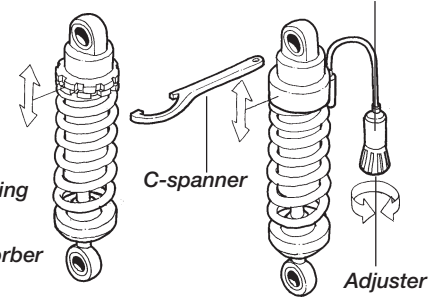

Tuning the suspension

Motorcycle road holding qualities

All motorcycles are designed with a suspension geometry that includes height and fork angle. The changing of components can affect this and it is therefore essential that both the rear and the front ends match each other.

Changing to Öhlins suspension gives optimum performance only when both the front fork and the rear suspension interact properly. It is of great importance that the front and rear loaded height are within the specified values.

See section: *Setting the spring pre-load.*

Design

All Öhlins shock absorbers are pressurised. The fluid is put under gas pressure and the gas and the fluid are kept apart by a separating piston. The separating piston is often fitted in a separate reservoir, connected by hose, or fixed directly on top of the shock absorber (piggyback).

There are also types of shock absorbers where everything is fitted inside the main cylinder tube (internal gas reservoir), and even a small number of emulsion shock absorbers that do not have a separating piston. Pressurisation of the fluid is made with nitrogen. The pressurisation prevents cavitation of the fluid and the shock absorbing action is therefore more even. The external reservoirs also contribute to better cooling of the fluid, giving longer service life for both the fluid and components.

Öhlins shock absorbers have integrated temperature compensation. As the temperature increases and the fluid flows more easily, the flow is controlled accordingly. The shock absorbing effect is there-

fore independent of the temperature.

The more advanced models permit individual adjustment of compression damping and rebound damping, and also certain adjustment of the length of the shock absorber.

Öhlins shock absorbers provide the possibility for adjustment, making them adaptable to most motorcycles, riders and ranges of use. All of the shock absorbers have adjustable pre-loading of the spring action; either mechanically or hydraulically.

3. Flow through needle valve

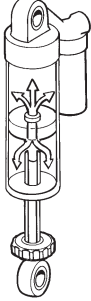

4. Piston with apertures

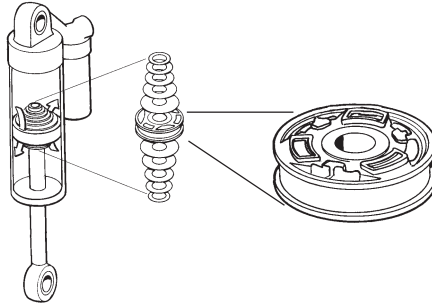

5. Shims stack

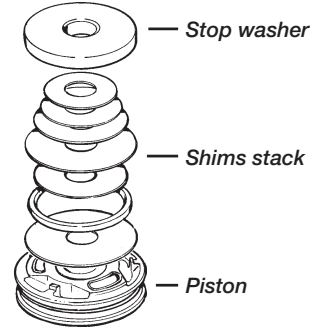

6. Flow through piston

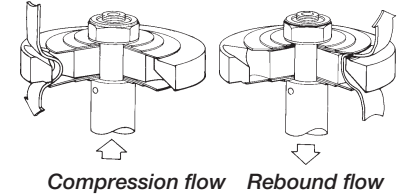

Function

Fluid is forced through needle valves at a low rate of flow (Fig.3) and through a number of apertures in the piston (Fig.4) at a high rate of flow. The flow through these apertures is regulated by shims (thin steel washers, Fig.5) that at high pressure are deflected to open for the fluid. On most models the needle valves can be set individually.

By altering the size of the shims stack (i.e. number, thickness, diameter) the characteristics of the damping action can be varied (this should only be done by Öhlins authorized service workshops).

Compression damping

When movement of the motorcycle causes compression in the shock absorber, the fluid flows through the needle valve (combined compression and return valve) in the piston rod. If velocity of the piston is high, i.e. in the case of rapid compression, this will not be sufficient and consequently the shims underneath the piston will open to allow a greater rate of flow (Fig.6).

The fluid that is displaced by the volume of the piston rod is forced into the external fluid chamber via a separate compression valve. Even this valve is fitted with shims that open at high piston velocity. The separating piston is displaced, thus increasing the gas pressure.

Rebound damping

When the spring presses the shock absorber out again, the fluid flows back through the needle valve in the piston rod. The fluid flowing into the chamber is forced by the pressure of the gas back into the shock absorber via a separate non return valve.

If velocity of the piston is high, the shims on top of the piston will also open to allow the fluid to flow through (Fig.6).

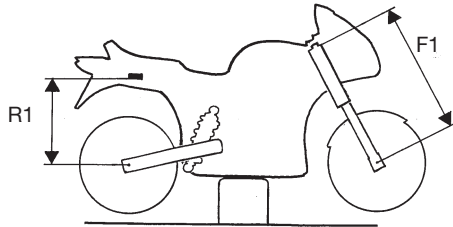

A-D. Bike on a stand
Suspension fully extended: (R1 and F1)

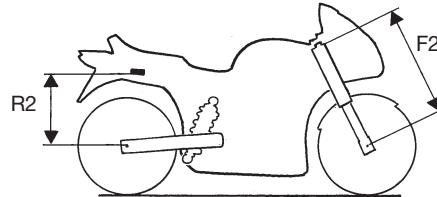

E. Bike on the ground
Static sag: (R1-R2, F1-F2)

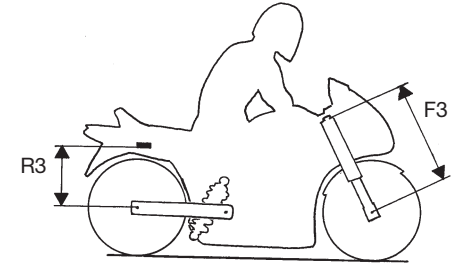

F. Bike with rider on
Ride height: (R1-R3, F1-F3)

Settings

Basic settings

Always ensure that the basic setting made by Öhlins is correct. It is adapted to the make and model (in its original state) and for a rider of average weight.

Spring pre-load

Pre-load on the spring/springs is very important because it affects the height of the motorcycle and the fork angle.

Everything must harmonize

In the recommendation table there are Öhlins front fork springs that are specifically adapted to the shock absorbers recommended for your motorcycle. If none is noted in the table, then "intact" original springs are the right choice. Incorrect spring action can produce a fork angle that is too steep or too flat. This in turn will give a tendency for oversteering or understeering, which could seriously affect the handling characteristics of the motorcycle.

Setting the spring pre-load

Measuring

Proceed as follows (it will be much easier if done by two persons):

- A** Place the motorcycle on a stand.
- B** Raise the rear end of the vehicle so that the suspension is in a fully extended position.
- C** Measure the distance, e.g. from the lower edge of the rear mud guard or from a point marked by a piece of tape, immediately above the rear wheel axle, to the wheel axle. (R1)
- D** Make a similar measurement on the front fork axle, e.g. from the bottom of the upper fork crown to the front wheel axle. The fork must also be fully extended. (F1)
- E** Allow the motorcycle (without rider) to apply load on the springs and repeat the measuring procedure. (R2, F2)
- F** Then take the same measurements with the rider and equipment on the motorcycle. (R3, F3)

NOTE!

It is important that the rider has a correct riding posture, so that the weight is balanced on the front and rear wheel in the same way as when riding.

The measurements must not differ from the following sizes:

Without rider (static sag):

Rear:	10-20 mm	(R1-R2)
Front:	15-30 mm	(F1-F2)

With rider (ride height):

Rear:	25-40 mm	(R1-R3)
Front:	35-50 mm	(F1-F3)

NOTE!

Older gear shaft drive driven motorcycles (not para lever shaft drive) usually raise the rear end during acceleration. We recommend that the static sag (R1-R2) is extended to 15-20 mm and the ride height (R1-R3) to 35-45 mm on these motorcycles.

7. Spring pre-load adjustment.

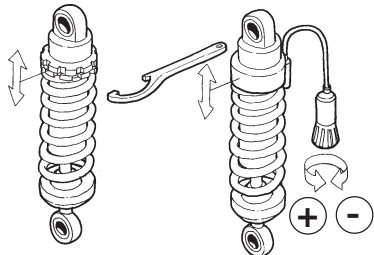

**A. Mechanical
pre-load adjuster**

**B. Hydraulic
pre-load adjuster**

Adjusting

Adjust the pre-load with the rings on the shock absorber or by hydraulic pre-loading. In the first case, hold the upper ring and adjust the lower one to the desired position (Fig.7A). Then lock with the upper ring.

For hydraulic pre-loading, increase by turning clockwise and reduce by turning counter clockwise (Fig.7B).

NOTE!

On shock absorbers that have mechanical type adjustment the position of the adjusting/pre-load rings can be adjusted. On a shock absorber that has hydraulic setting the basic position can be adjusted. Such changes should be attended to by an Öhlins authorized service workshop.

The original setting of the shock absorber, when delivered from Öhlins, should always be a base when the settings are changed by use of the adjustment devices.

NOTE!

The spring pre-load affects the ride height, it does not affect the spring stiffness.

Therefore, on models with a linkage to the shock absorber, the suspension may actually feel harder when you reduce the pre-load and the shock absorber gets into the harder range of the link system.

8. Front fork spring kit

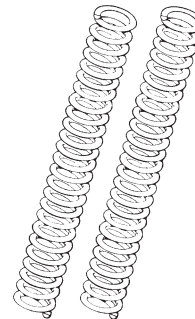

Front fork springs

To optimize the road holding qualities of a motorcycle the front fork must match the rear suspension.

Öhlins springs are available for a large number of motorcycles (Fig.8). These, in combination with Öhlins shock absorbers, contribute to superior road holding qualities. The original make of springs should be used if there are none of our springs in the recommendation table. However, they must be in good condition and not fatigued.

Remember to change the fluid in the front fork at least once every year.

We recommend Öhlins front fork oil. See table.

NOTE!

It is important that the recommendation table is followed for new front springs. If there are no recommended front springs you must ensure that the existing springs are in good condition. Neglecting to check the front springs could seriously affect the handling qualities of the motorcycle.

9. Adjustment of rebound damping

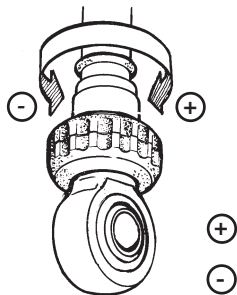

Setting the damping

The adjusting possibilities of Öhlins shock absorbers facilitate fine setting. You can optimize adjustments to suit your own weight and equipment, your individual way of riding and the condition of the road. To be able to improve the road holding qualities it is of the utmost importance that you fully understand the functioning of the shock absorbers. Then you can learn by trial and error how they affect the motorcycle.

Depending on the model there are adjustments for rebound damping, compression damping and adjustment of the length of the shock absorber. Damping is set with knobs and screws with a normal right-hand thread. By turning them clockwise the damping action is increased, and by turning them counter clockwise it is reduced. The knobs have definite positions with noticeable "clicks", making it is easy to count to the right setting.

Rebound damping action affects the characteristics of the motorcycle most. The setting knob is located at the bottom on the piston rod (Fig.9). It can be adjusted in about 40 steps.

10. Adjustment of compression damping

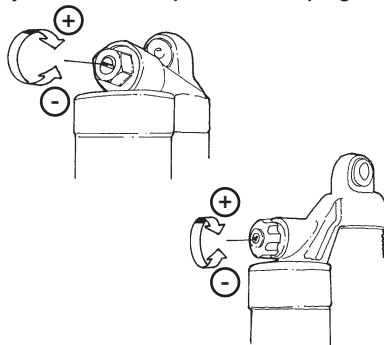

NOTE!

If no "click" is felt in the rebound adjuster, the shock absorber must be inspected by an authorized service workshop. It could be due to low gas pressure or lack of oil.

The compression damping knob is located at the end of the external reservoir (Fig.10). This can be adjusted in about 25 steps.

Some models (PRX) have separate adjusters for high speed compression and low speed compression (Fig.11). The low speed compression is adjusted in 25 steps. Use a slotted head screw driver.

The high speed adjuster has a wide range within about 48 clicks. Use a 14 mm key.

NOTE!

When making new adjustments it is easiest to go back to fully closed, and then count forward to the new setting. The adjusting device should not be turned too hard.

11. High and low speed compression damping adjusters

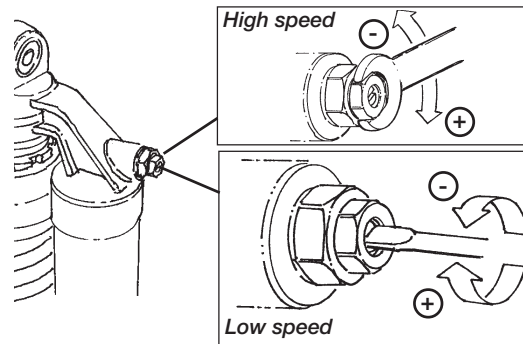

CAUTION!

The hexagon of a two way compression valve is naturally anodized aluminum. The high speed adjuster has a key width of 14 mm and a range of 48 steps (clicks). The low speed adjuster (slotted head screw) has a range of 25 steps.

The one way compression adjuster is gold anodized. The adjuster (slotted head screw) has a range of 25 steps. Do not turn the hexagon as this will allow for the oil to spurt out of the shock absorber.

NOTE!

High and low speed refers to the shaft velocity of the shock absorber. It is not necessarily related to the speed of the vehicle.

EC – Electronic Control Settings

Setting the damping

The electronically controlled compression damping is set with the control panel of the electronic unit.

You can instantly optimize adjustments to suit your individual way of riding and the condition of the road.

Compression damping adjustments are made by setting the electronic adjustment device. By setting high figures the damping action will increase and low figures reduces the damping.

New settings will affect the damping within ten [10] milliseconds. High figures are recommended when riding with greater load (eg. passenger and packing) and when riding on a race track.

To be able to improve the road holding qualities it is of the utmost importance that you fully understand the functioning of the shock absorbers. Please refer to the Mounting Instructions, as well as page five (5) of this manual for basic setup (spring pre-load). Then you will learn by trial and error how they affect the vehicle.

The control unit

The control unit display has a window with two sections, showing how much damping power the shock absorber and the front fork have. The upper section shows the front fork damping and the lower section shows the rear wheel damping. If the electronic control unit operates one shock absorber only, the damping force is read in the upper display and the lower display shows the electrical voltage of the motorcycle.

By pressing the ÖHLINS logotype you choose front or rear setting and by pushing the + or – buttons you increase or decrease the damping forces. The higher the figures, the stronger the damping forces.

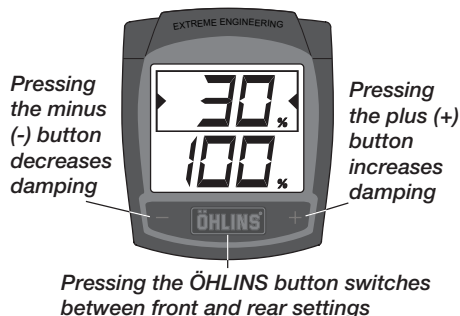

NOTE!

The control unit will automatically switch to the correct mode: single suspension or front and rear suspension.

Functions for front and rear suspension:

- A Press for front suspension
- B Press for rear suspension
- C Press for front and rear
After C the function returns to A.

NOTE!

If the button is pressed for at least one second the display will show the voltage for five seconds.

Functions for single suspension only:

- A Press for voltage readings
- B Press to turn the voltage readings off
After B the function returns to A

WARNING!

Do not alter the damping when riding in traffic. The motorcycle must come to a stop before the damping is set. To avoid dangerous situations, do not take your eyes and attention off the traffic and your surroundings.

When the motorcycle is restarted the adjusters will return to the earlier chosen positions. If the power supply should fail the shock absorber will retain its last applied damping force settings, to ensure safe riding.

Troubleshooting

- Er1 **No power to the front damper**
Measures: Make sure the damper is connected. Check cables and connections for damages.
- Er2 **No power to the rear damper**
Measures: Make sure the damper is connected. Check cables and connections for damages.
- Er3 **No power to front and rear dampers**
Measures: Make sure the dampers are connected. Check cables and connections for damages.
- Er4-Er7 **Insufficient voltage to the control unit**
Measures: Check battery and alternator. Check all connections.

NOTE!

If you have two dampers connected to the control unit and one of them suffers a cable failure while the power is off, the control unit will automatically switch to single damper mode next time it is powered on. Er1 and Er2 will only show up if the connection fails during power on.

12. Rebound damping

- Unstable
- Loose
- Bouncy

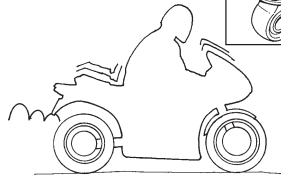
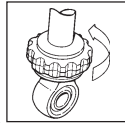

Increase

- Hard
- Bumpy

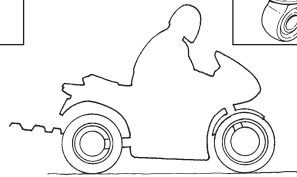
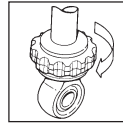

Reduce

13. Compression damping

- Unstable
- Soft
- Low
- Bottom

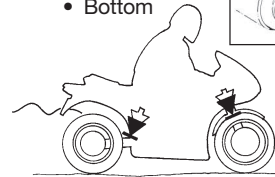
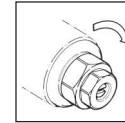

Increase

- Harsh
- Hard
- Bad grip

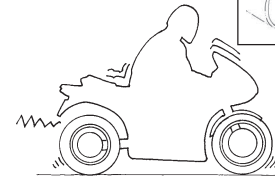
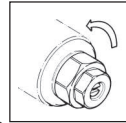

Reduce

Setting your motorcycle

NOTE!

Always begin with the basic settings recommended by Öhlins. Always make notes, adjust in small steps and make only one adjustment at a time. Adjustments should be made with two steps (clicks) at a time. Adjustments should not be more than four steps from the basic setting.

By utilizing the adjustment possibilities you can test by trial and error, and learn how they affect your motorcycle.

Always begin by test riding the motorcycle with all adjustments at their delivery setting. Choose a short run of varying character, i.e. long and sharp bends, hard and soft bumps. Keep to the same run and adjust only one setting at a time.

Start with the rebound damping (Fig.12):

If the motorcycle feels unstable, loose and rather bouncy then the rebound damping should be increased. Begin by turning the adjusting knob 4 steps (clicks) clockwise. Test run again and adjust two steps back if it felt too hard and bumpy.

If the motorcycle is hard and bumpy, especially over a series of bumps, then the rebound damping should be reduced. Turn counter clockwise 4 steps, test run and make any necessary correction to 2 steps.

Compression damping (Fig.13):

The low speed compression adjuster affects ride height, smoothness over small bumps and grip. The high speed compression adjuster affects stability, firmness in depressions and fast corners.

If the motorcycle has a low riding position, the low speed compression should be increased. Turn clockwise four steps and test run again. If this was too much then turn back two steps

(counter clockwise). If it feels unsmooth over small continuous bumps or has bad grip, the low speed compression should be decreased. Turn counter clockwise four steps. Test run and make any necessary correction in two steps at the time.

If the motorcycle feels unstable in fast corners and has a tendency to bottom easily in depressions and chicanes, the high speed compression should be increased. Turn clockwise six steps and test run again. If this was too much then turn back three steps (counter clockwise). If it feels harsh and too rigid or has a tendency to hop during braking, the high speed compression should be decreased. Turn counter clockwise six steps. Test run and make any necessary correction in three steps at the time.

When you have sufficient feel of the motorcycle you can make further fine adjustments. It is feeling and experience that counts.

14. Adjustment of shock absorber length

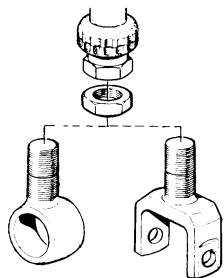

NOTE!

Ensure that the springs are properly pre-loaded before attempting to make any adjustments. A simple rule is that increased pre-load of the spring should be followed by an increase of rebound damping by two steps.

When you feel that you have achieved an improvement, go back to where you started and check once more. Be observant of other relevant factors such as tyres, temperature, etc. Test run to make sure whether further fine adjustment should be made.

15. Adjusting the shock absorber length

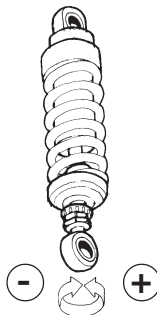

Setting the shock absorber length

Sensitivity of the steering can be adjusted by altering the length of the shock absorber, without affecting other characteristics. The length is adjusted using two nuts down and the treaded clevis at the end of the piston rod (Fig.14). The shock absorber can be adjusted up to 12 mm.

16. Groove

WARNING!

If the shock absorber has an adjustable end eye/bracket, this must not be threaded out more than that one groove is fully visible beneath the lock nut. Make sure that the lock nut is tightened after adjustment.

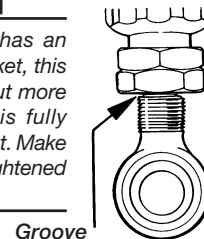

Adjusting the shock absorber length

A long shock absorber results in steeper inclination of the front fork (steeper fork angle) and consequently sensitive, quicker steering. A short shock absorber gives a greater angle of the front fork (flat fork angle) and consequently slower and smoother steering. Each complete turn of the shock absorber gives one millimetre (Fig.15). The length may never be altered more than to where the groove (Fig.16) that is cut in the thread becomes just visible under the lower nut of the level bracket. Make small steps and test run.

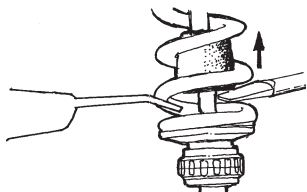

17. Lift the bump rubber and clean the area below

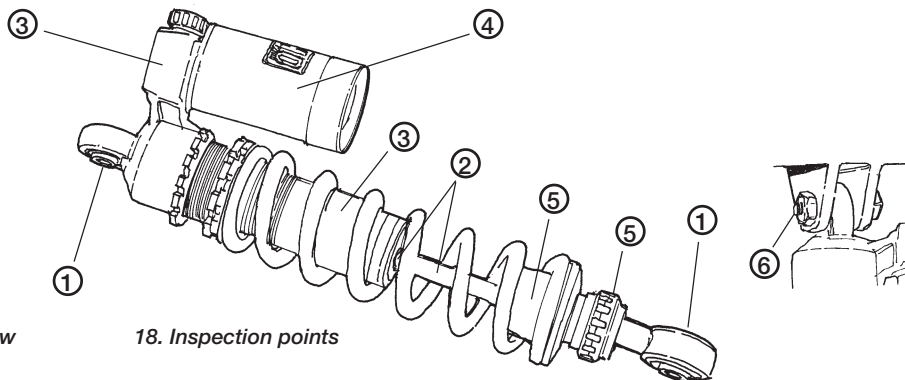

18. Inspection points

Inspection and maintenance

Clean the shock absorbers externally with a soft detergent. Use compressed air. Lift the bump rubber and clean the area below (Fig.17). Keep the shock absorbers clean and always spray them with oil (QS 14, WD40 or CRC 5-56 or similar).

CAUTION!

Never use detergents that can damage the surfaces of the shock absorber. Thinner and brake cleaner will dry the surfaces too much.

WARNING!

Never alter the gas pressure. Special purpose charging equipment and access to nitrogen is required. The gas pressure should normally never be altered.

Inspection points (Fig.18):

- 1 Check ball joints for possible excessive play.
 - 2 Check the piston shaft for leakage and damage
 - 3 Check the shock absorber body for external damage.
 - 4 Check the external reservoir for damages that can restrict the floating piston from moving freely.
 - 5 Excessive wear of rubber components.
 - 6 Check that the shock absorber is securely fastened to the vehicle.
- Check the hose equipped models for leaks in hose and inlet plugs.

Preventive maintenance and regular inspection reduces the risk of functional disturbance. If there is any need for additional service, please get in touch with an authorized Öhlins service workshop. There you will find the necessary tools and know-how for all your needs.

NOTE!

Make certain that your shock absorbers are always filled with Öhlins High Performance Suspension fluid.

NOTE!

Regular maintenance and inspection contribute to the prevention of functional disturbances.

Recommended service intervals:

Race track	Every 10 hours
Street/Road	Every 20 000-30 000 km

NOTE!

Discarded Öhlins products should be handed over to an authorized work shop or distributor for proper disposal.

More info

www.ohlins.com

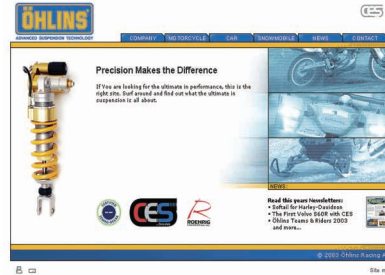

The ultimate suspension site.
Find out everything about your suspension.
Download mounting instructions, manuals and brochures.
And a lot more.



Öhlins Racing AB, Box 722, S-194 27 Upplands Väsby, Sweden
Phone +46 8 590 025 00, Fax +46 8 590 025 80

Your Öhlins dealer: